

Single circuit track system / 三线（一回路）轨道系统

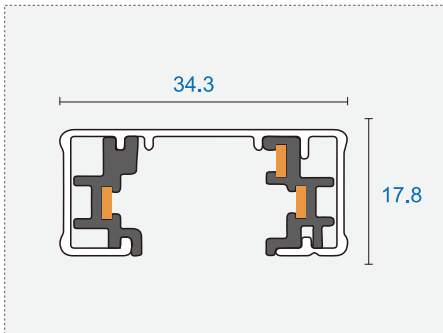

Colour 颜色	Track length 轨道长度	Model No. 型号
White/Silver/Black	1M track with double end cap 1M 路轨 含双尾盖	Pro-0310A
White/Silver/Black	2M track with double end cap 2M 路轨 含双尾盖	Pro-0320A
White/Silver/Black	3M track with double end cap 3M 路轨 含双尾盖	Pro-0330A
White/Silver/Black	4M track with double end cap 4M 路轨 含双尾盖	Pro-0340A
White/Silver/Black	1M track with live end & end cap 1M 路轨 含电源接头和尾盖	Pro-0310B
White/Silver/Black	2M track with live end & end cap 2M 路轨 含电源接头和尾盖	Pro-0320B
White/Silver/Black	3M track with live end & end cap 3M 路轨 含电源接头和尾盖	Pro-0330B
White/Silver/Black	4M track with live end & end cap 4M 路轨 含电源接头和尾盖	Pro-0340B
White/Silver/Black	1M track without live end and end cap 1M 路轨 不含电源接头和尾盖	Pro-0310C
White/Silver/Black	2M track without live end and end cap 2M 路轨 不含电源接头和尾盖	Pro-0320C
White/Silver/Black	3M track without live end and end cap 3M 路轨 不含电源接头和尾盖	Pro-0330C
White/Silver/Black	4M track without live end and end cap 4M 路轨 不含电源接头和尾盖	Pro-0340C

Reference diagram for choice of connectors / 连接器选择参考图示

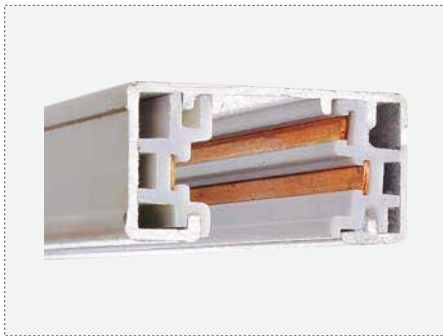
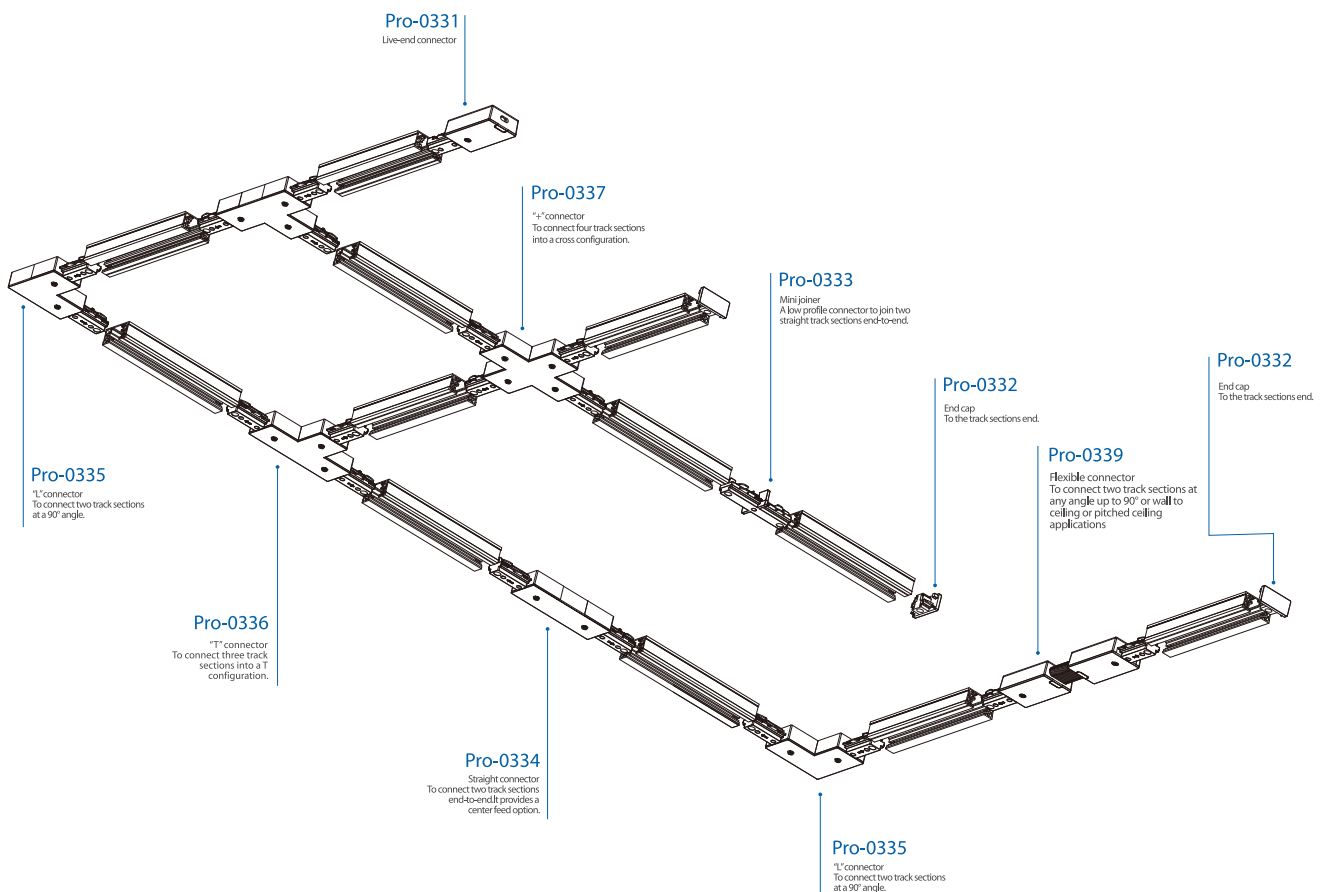



Live-end connector / 电源接头

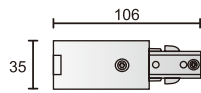

Colour 颜色	Model No. 型号
White	Pro-0331-W
Silver	Pro-0331-S
Black	Pro-0331-B



End cap / 尾盖  
To the track sections end.

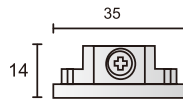

Colour 颜色	Model No. 型号
White	Pro-0332-W
Silver	Pro-0332-S
Black	Pro-0332-B



Mini joiner / 导电接头  
A low profile connector to join two straight track sections end-to-end.

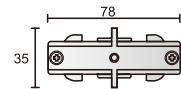

Colour 颜色	Model No. 型号
White	Pro-0333-W
Silver	Pro-0333-S
Black	Pro-0333-B



Straight connector / 直连接头  
To connect two track sections end-to-end. It provides a center feed option.

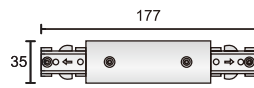

Colour 颜色	Model No. 型号
White	Pro-0334-W
Silver	Pro-0334-S
Black	Pro-0334-B



"L" connector / "L" 接头  
To connect two track sections at a 90° angle

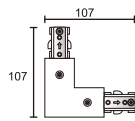

Colour 颜色	Model No. 型号
White	Pro-0335-W
Silver	Pro-0335-S
Black	Pro-0335-B



"T" connector / "T" 接头  
To connect three track sections into a T configuration.

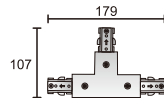

Colour 颜色	Model No. 型号
White	Pro-0336-W
Silver	Pro-0336-S
Black	Pro-0336-B



"+" connector / "+" 接头  
To connect four track sections into a cross configuration.

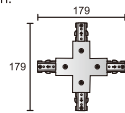

Colour 颜色	Model No. 型号
White	Pro-0337-W
Silver	Pro-0337-S
Black	Pro-0337-B



Flexible connector / 软接头  
To connect two track sections at any angle wall up to 90° or wall to ceiling or pitched applications

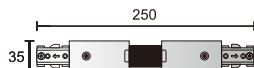

Colour 颜色	Model No. 型号
White	Pro-0339-W
Silver	Pro-0339-S
Black	Pro-0339-B



Floating canopy / 活动式电源盒

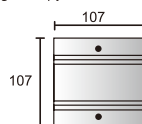

Colour 颜色	Model No. 型号
White	Pro-0341-W
Silver	Pro-0341-S
Black	Pro-0341-B